

effect

8 MM

10 MM *Exclusive*

12 MM *Premium*

FLOORING

PARKE

 **AGT**



Evinizde doęa yryşne hazır mısınız?

**Desenleriyle birebir eşleşen dokusu ile
Effect Parke Serisi doęayı ayađınıza getiriyor.**

Are you ready for nature walk in your house?

With its perfectly matching surface and patterns,
the Effect Flooring Series brings the nature to you.

AGT



Yüzey yapısının tasarımla mükemmel uyumu ile Effect 8 mm ve Effect 10 mm Exclusive Parke, dayanıklılığı, ses ve ısı yalıtımı artırılmış özellikleri ile de Effect 12 mm Premium Parke sizlerle...

Feel the perfect match of surface structure with the design in Effect 8 mm and Effect 10 mm Exclusive Flooring, while Effect 12 mm Premium Flooring offers durability and enhanced features of sound and heat insulation.

Alp	6 - 9
Pamir	10 - 13
Ural	14 - 17
Fuji	18 - 21
Tibet	22 - 25
Altay	26 - 29
Everest	30 - 33
Toros	34 - 37
Teknik Özellikler / Technical Specifications	38 - 41
Süpürgelik Profilleri / Skirting Profiles	42 - 45

AGT

effect

8
mm



15
YIL GARANTİ
Mükemmel Ses Yalıtımı

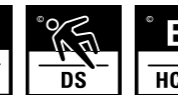

E1
HCHO

DL
PCP



V

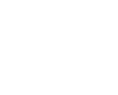

L2C
TEKNOLOJİSİ

TS EN
13329+A1
Standartına göre
test edilmiştir.

effect
Exclusive

10
mm

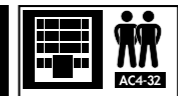

15
YIL GARANTİ
Mükemmel Ses Yalıtımı

effect
Premium

12
mm

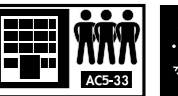

20
YIL GARANTİ
Mükemmel Ses Yalıtımı

Renkler basılı ve dijital kataloqlarda farklılık gösterebilir. Lütfen, satış noktalarımızda bulunan gerçek ürünler ile karşılaştırınız.

Colors may vary in digital and printed catalogs. Please compare with the actual products in the sales points.



alp



Katalogdaki renk ve gerçek ürün rengi arasında ton farklılıkları olabilir.

Colour tones shown in the catalog may differ on actual products.



alp

Eviniz manzara resimlerini andırsın.

Büyülü dağların, kar ve bulutların beyazıyla bütünleşmiş atmosferinden ilham alan Alp ile mekanınızda ferah bir hisse sahip olun.

Let your house look like a landscape photo.

Feel refreshing at home with Alp series, created with the inspiration of the atmosphere where white color of magical mountains, snow and clouds became one.

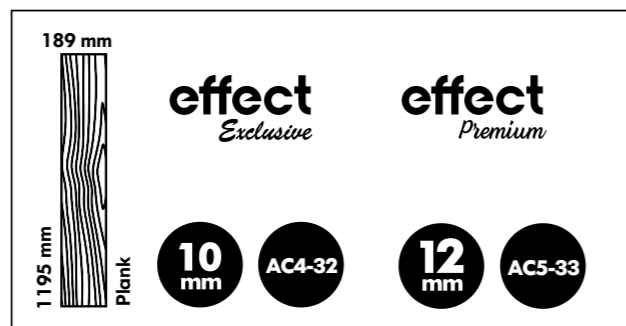
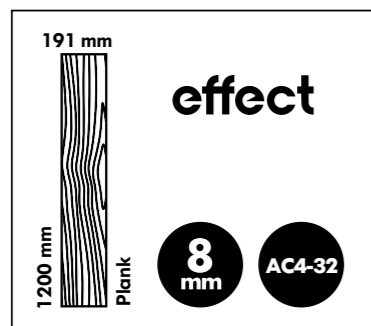



pamir



pamir

Orta Asya'nın zirvelerinden gelen miras.

Sıradağların renginden ilham alan Pamir ile mekanlarınızda doğanın tadını çıkarın.

A legacy from the summits of Central Asia.

With Pamir inspired by the color of the mountain range, enjoy the scenery in your place.



Katalogdaki renk ve gerçek ürün rengi arasında ton farklılıkları olabilir.

Colour tones shown in the catalog may differ on actual products.

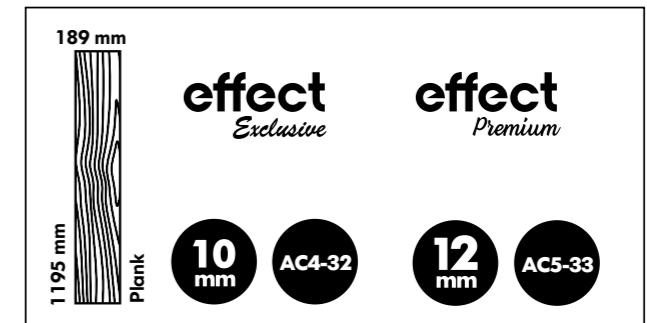
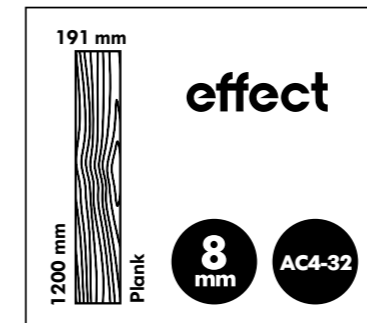



ural



ural

Kendine has asaleti ile toprak tonlarını hissedin.

Ural Dağları'nın toprak tonları mekanlarınızda hayat bulacak.

Feel the earth tones with Ural's unique royal look.

The earth tones of the Ural Mountains will spring to life in your place.



Katalogdaki renk ve gerçek ürün rengi arasında ton farklılıkları olabilir.

Colour tones shown in the catalog may differ on actual products.

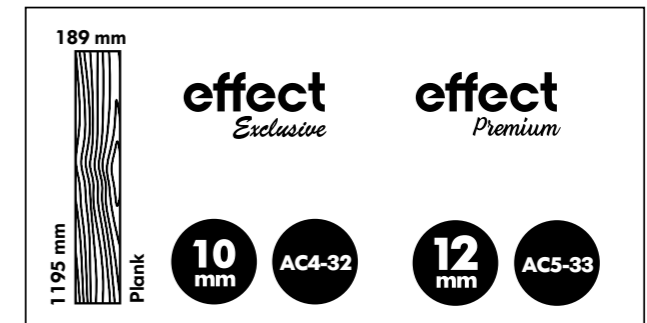
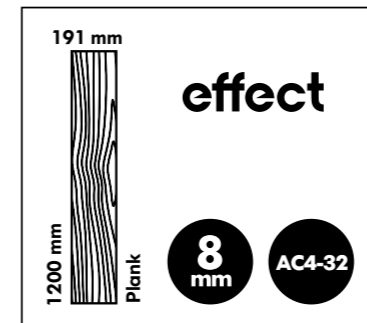



fuji



fuji

Gün batımının dayanılmaz cazibesi...

Fuji Dağları'nın gün batımını andıran renginden ilham alarak mekanlarınızda doğal bir görünüm elde edebilirsiniz.

The irresistible lure of the sunset...

Inspired by the sunset-like color of the Fuji Mountains, get a natural look in your place.



Katalogdaki renk ve gerçek ürün rengi arasında ton farklılıkları olabilir.

Colour tones shown in the catalog may differ on actual products.

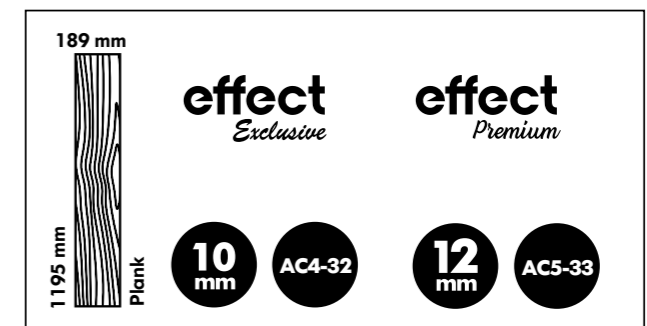
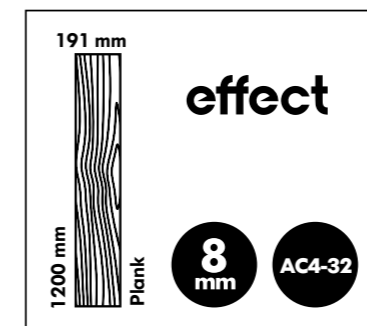



tibet



tibet

**Evinizde mistik atmosfer
yer kaplasın.**

**Asya'nın topraklarından
ilham alan Tibet ile doğa
ayaklarınızın altında.**

Let your house have a mystical
atmosphere.

Inspired by the lands of Asia,
nature is just under your feet
with Tibet.



Katalogdaki renk
ve gerçek ürün
rengi arasında ton
farklılıkları olabilir.

Colour tones shown in
the catalog may differ
on actual products.

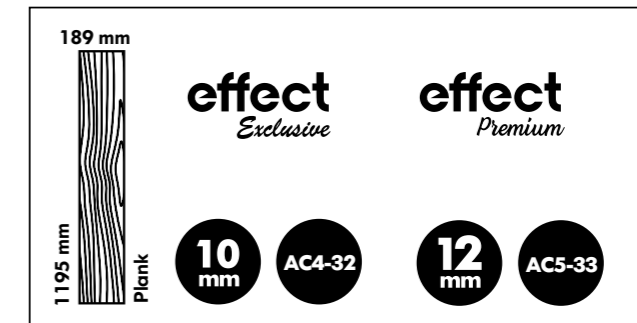
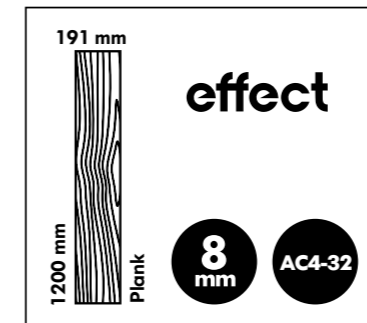



altay



Katalogdaki renk ve gerçek ürün rengi arasında ton farklılıkları olabilir.

Colour tones shown in the catalog may differ on actual products.



altay

Estetiğin doruk noktasına ulaşın.

Altın, demir, bakırla dolu sıradağların zengin renginden ilham alan Altay, farklı bir görünüme ayak basmanızı sağlayacak.

Reach to peak of aesthetics.

Inspired from the rich color of the chain of mountains full of gold, iron and copper, Altay will let you to experience a different view in your place reminding of red color.

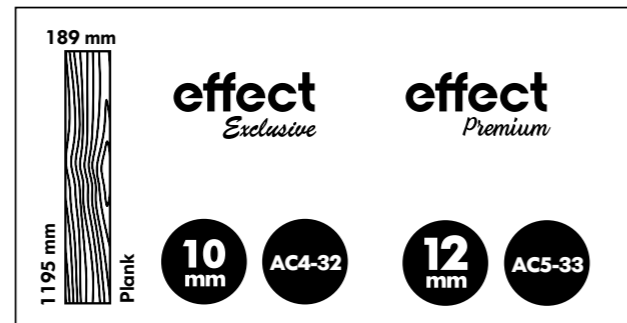
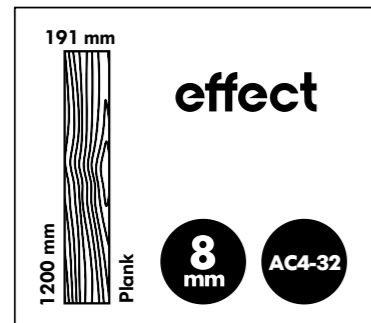
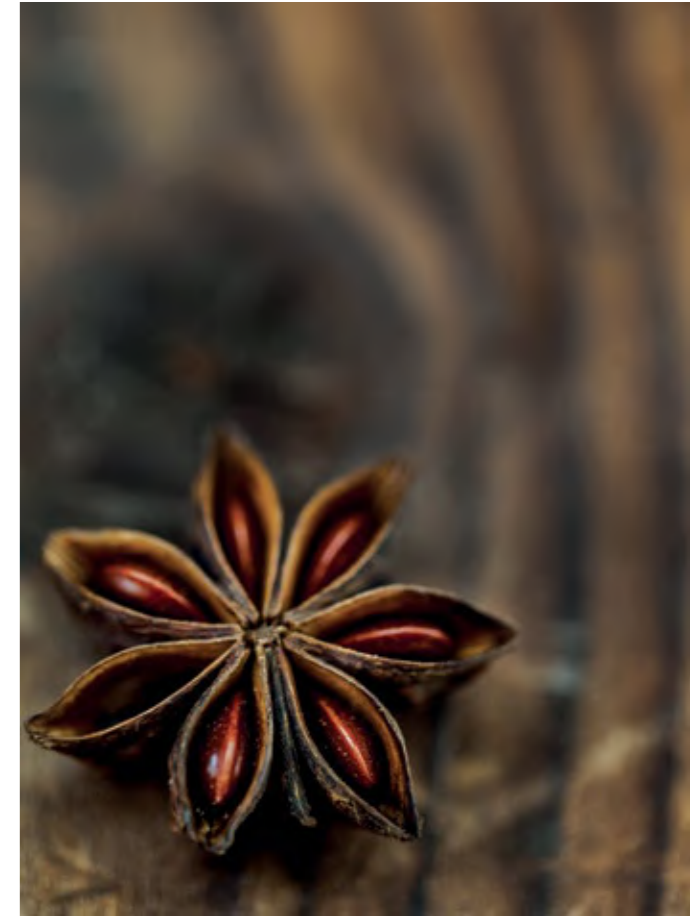



everest



Katalogdaki renk ve gerçek ürün rengi arasında ton farklılıkları olabilir.

Colour tones shown in the catalog may differ on actual products.



everest

Zirvelerden gelen doğallık.

Bulutların arasından sıyrılan dağın renk bütünlüğünden ilham alan Everest ile mekanlarınızda hayal ettiğiniz görünümün zirve noktasına ulaşacaksınız.

Naturalness, coming from the summits.

Everest Series, inspired from the color integrity of the mountain emerging between clouds will enable you to reach to peak of the view that you have dreamed in your place.

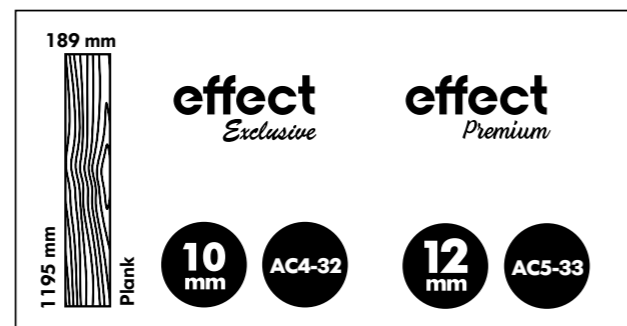
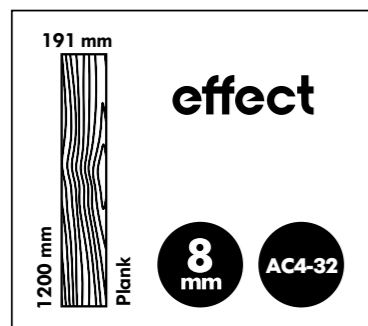



toros



Katalogdaki renk ve gerçek ürün rengi arasında ton farklılıkları olabilir.

Colour tones shown in the catalog may differ on actual products.

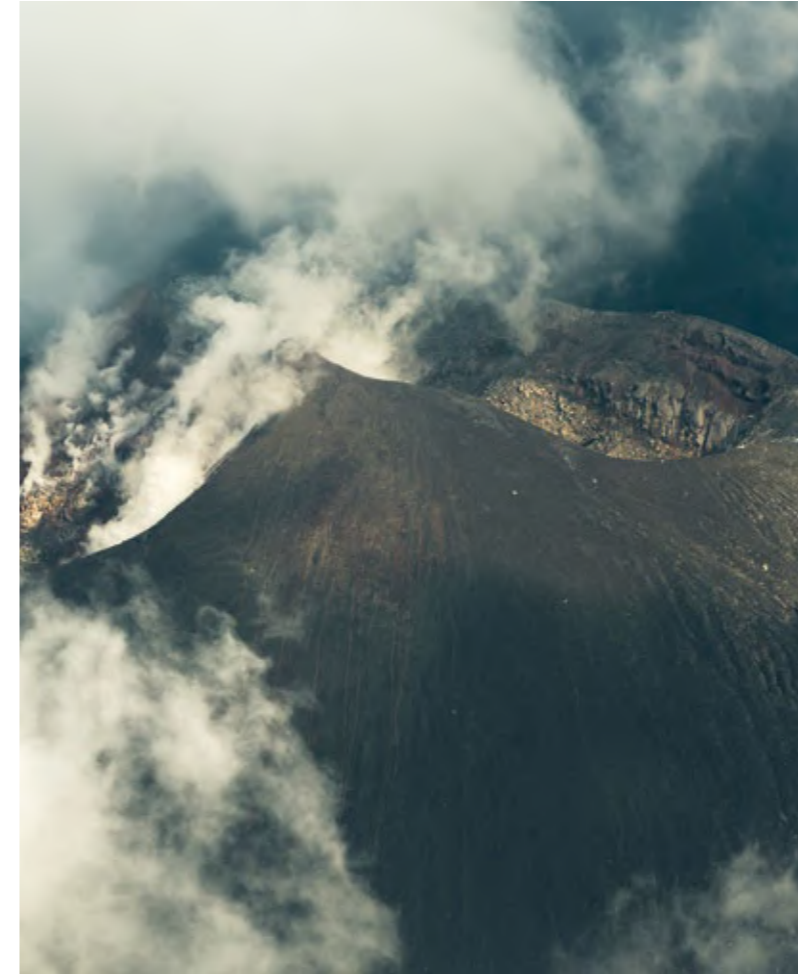

toros

Mekanlarınıza görkem katın.

Çeşit çeşit bitki türünün renk paletini içinde barından Toros, mekanlarınıza görkemli bir görünüm kazandıracak.

Add glory in your house.

By containing the color palette of various plant species, Toros Series will make your house to have a magnificent view.

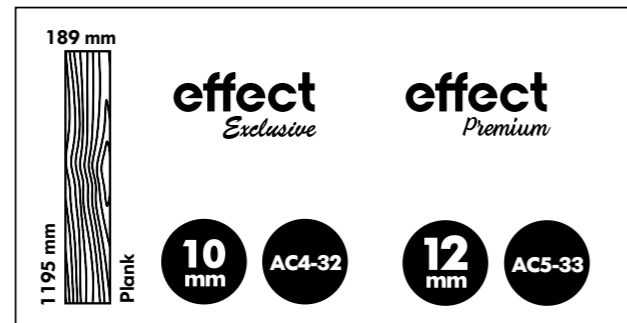
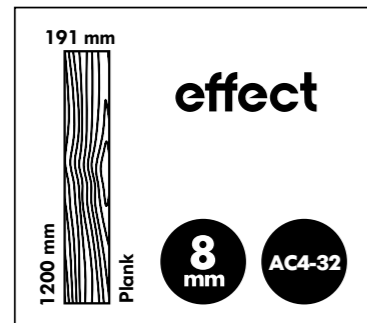

effect

TEKNİK ÖZELLİKLER / TECHNICAL SPECIFICATIONS

ÖZELLİKLER / SPECIFICATIONS	STANDART / STANDART	SONUÇLAR / RESULTS
Elemanlar arası kalınlık farkı Thickness difference between elements	EN 13329	T ortalama< 0,50 mm t max-t min<0,50 mm T average< 0,50 mm t max-t min<0,50 mm
Aşınma dayanımı Abrasion Resistance	EN 438	Devir>4000 Cycle>4000
Elemanın baş kısım gönye sapması Deviation from squareness of element	EN 13329	Q max< 0,2mm
Yüzey tabakasının uzunluğu Length tolerance	EN 13329	l<1500mm l fark<0,5mm l<1500mm l difference<0,5mm
Yüzey tabakasının genişliği Width tolerance	EN 13329	W ortalama fark 0,10mm w max- w min<0,20mm W average difference 0,10mm w max- w min<0,20mm
Kılıcına dönme miktarı Edgewise bending	EN 13329	0,30 mm
Elemanın yüzey düzgünlüğü Surface smoothness	EN 13329	Fw içbükey <%0,15 fw dışbükey <%0,20 F1 içbükey <%0,50 fl dışbükey <%1,00 Fw concave <%0,15 fw convex <%0,20 F1 concave <%0,50 fl convex <%1,00
Elemanlar arası açıklık Space between elements	EN 13329	O ortalama<0,15mm o max 0,15mm O average<0,15mm o max 0,15mm
Elemanlar arası yükseklik farkı Height difference between elements	EN 13329	H ortalama< 0,10mm H max<0,15mm H average< 0,10mm H max<0,15mm
Yüzey sağlamlığı Surface soundness	EN 13329	>1 N/mm ²
Çizilme mukavemeti (N) Scratch resistance	EN 438	>3,5
Solma dayanımı (UV) UV resistance	EN ISO105	Mavi yün ölçek bölüm 02, 6'dan daha kötü değil 6 için yeterli Blue wool scale part is not worse than 02,6; enough for 6
Çarpma mukavemeti Impact resistance	EN 13329	32. sınıf için IC2 IC2 for 32th class
Koltuk tekerleği etkisi Determination of the effect of a castor chair	EN 425	Görünümde bir değişiklik veya zarar olmayacak No change or damage on appearance should occur
Mobilya ayağı etkisi Determination of the effect of a castor furniture	EN 424	Görülebilir zarar olmamalıdır. No visible damage should occur
Sıcak kaplara dayanıklılık Resistance to hot pots	EN 13329	Sınıf 4 / Class 4
Sigara ateşine karşı dayanıklılık Resistance to cigarette burns fire	EN 13329	Sınıf 4 / Class 4
Su buharına karşı dayanıklılık Resistance to water vapor	EN 13329	Sınıf 4 / Class 4
Leke tutmaya karşı dayanıklılık Stain resistance	EN 13329	Sınıf 5 / Class 5
24 saat suda şişme 24 hours swelling in thickness	EN 13329	<%18
Yoğunluk Density	EN 323	850-900 kg/m ³
Eğilme dayanımı Bending strenght	EN 317	40 N/mm ²
Elastikiyet modülü Modulus of elasticity	EN 310	3500 N/mm ²
Çekme dayanımı Vertical internal bond	EN 319	≥1,2 N/mm ²

effect

Exclusive

effect

Premium

TEKNİK ÖZELLİKLER / TECHNICAL SPECIFICATIONS

ÖZELLİKLER / SPECIFICATIONS	STANDART / STANDART	SONUÇLAR / RESULTS
Elemanlar arası kalınlık farkı Thickness difference between elements	EN 13329	T ortalama< 0,50 mm t max-t min<0,50 mm T average< 0,50 mm t max-t min<0,50 mm
Aşınma dayanımı Abrasion Resistance	EN 438	Devir>6000 Cycle>6000
Elemanın baş kısım gönye sapması Deviation from squareness of element	EN 13329	Q max< 0,2mm
Yüzey tabakasının uzunluğu Length tolerance	EN 13329	l<1500mm l fark<0,5mm l<1500mm l difference<0,5mm
Yüzey tabakasının genişliği Width tolerance	EN 13329	W ortalama fark 0,10mm w max- w min<0,20mm W average difference 0,10mm w max- w min<0,20mm
Kılıcına dönme miktarı Edgewise bending	EN 13329	0,30 mm
Elemanın yüzey düzgünlüğü Surface smoothness	EN 13329	Fw içbükey <%0,15 fw dışbükey <%0,20 F1 içbükey <%0,50 fl dışbükey <%1,00 Fw concave <%0,15 fw convex <%0,20 F1 concave <%0,50 fl convex <%1,00
Elemanlar arası açıklık Space between elements	EN 13329	O ortalama<0,15mm o max 0,15mm O average<0,15mm o max 0,15mm
Elemanlar arası yükseklik farkı Height difference between elements	EN 13329	H ortalama< 0,10mm H max<0,15mm H average< 0,10mm H max<0,15mm
Yüzey sağlamlığı Surface soundness	EN 13329	>1,25 N/mm ²
Çizilme mukavemeti (N) Scratch resistance	EN 438	>3,5
Solma dayanımı (UV) UV resistance	EN ISO105	Mavi yün ölçek bölüm 02, 6'dan daha kötü değil 6 için yeterli Blue wool scale part is not worse than 02,6; enough for 6
Çarpma mukavemeti Impact resistance	EN 13329	33. sınıf için IC3 IC3 for 33th class
Koltuk tekerleği etkisi Determination of the effect of a castor chair	EN 425	Görünümde bir değişiklik veya zarar olmayacak No change or damage on appearance should occur
Mobilya ayağı etkisi Determination of the effect of a castor furniture	EN 424	Görülebilir zarar olmamalıdır. No visible damage should occur
Sıcak kaplara dayanıklılık Resistance to hot pots	EN 13329	Sınıf 4 / Class 4
Sigara ateşine karşı dayanıklılık Resistance to cigarette burns fire	EN 13329	Sınıf 4 / Class 4
Su buharına karşı dayanıklılık Resistance to water vapor	EN 13329	Sınıf 4 / Class 4
Leke tutmaya karşı dayanıklılık Stain resistance	EN 13329	Sınıf 5 / Class 5
24 saat suda şişme 24 hours swelling in thickness	EN 13329	<%18
Yoğunluk Density	EN 323	850-900 kg/m ³
Eğilme dayanımı Bending strenght	EN 317	40 N/mm ²
Elastikiyet modülü Modulus of elasticity	EN 310	3500 N/mm ²
Çekme dayanımı Vertical internal bond	EN 319	≥1,2 N/mm ²

SINIFI / CLASS

effect	KONUTLARDA / HOUSES			OFİSLERDE / OFFICES		
	Az / Low	Orta / Medium	Yoğun / High	Az / Low	Orta / Medium	Yoğun / High
Aşınma sınıfları Abrasion classes	21	22	23	31	32	33
	AC1	AC2	AC3	AC4		AC5
Ortalama aşınma değeri / Average abrasion value	> 900	>1500	>2000	>4000		>6000
	PAKET İÇİ ADET/ UNITS PER PACKAGE: 8		PAKET/ PACKAGE m ² : 1,8336	PAKET İÇİ AĞIRLIK/ WEIGHT PER PACKAGE: 13,20 KG		



SINIFI / CLASS

effect Exclusive	KONUTLARDA / HOUSES			OFİSLERDE / OFFICES		
	Az / Low	Orta / Medium	Yoğun / High	Az / Low	Orta / Medium	Yoğun / High
Aşınma sınıfları Abrasion classes	21	22	23	31	32	33
	AC1	AC2	AC3	AC4		AC5
Ortalama aşınma değeri / Average abrasion value	> 900	>1500	>2000	>4000		>6000
	PAKET İÇİ ADET/ UNITS PER PACKAGE: 6		PAKET/ PACKAGE m ² : 1,3551	PAKET İÇİ AĞIRLIK/ WEIGHT PER PACKAGE: 12,20 KG		



SINIFI / CLASS

effect Premium	KONUTLARDA / HOUSES			OFİSLERDE / OFFICES		
	Az / Low	Orta / Medium	Yoğun / High	Az / Low	Orta / Medium	Yoğun / High
Aşınma sınıfları Abrasion classes	21	22	23	31	32	33
	AC1	AC2	AC3	AC4	AC5	
Ortalama aşınma değeri / Average abrasion value	> 900	>1500	>2000	>4000	>6000	
	PAKET İÇİ ADET/ UNITS PER PACKAGE: 6		PAKET/ PACKAGE m ² : 1,3551	PAKET İÇİ AĞIRLIK/ WEIGHT PER PACKAGE: 14,60 KG		



EFFECT PARKENİN YAPISI / LAYERS OF EFFECT FLOORING

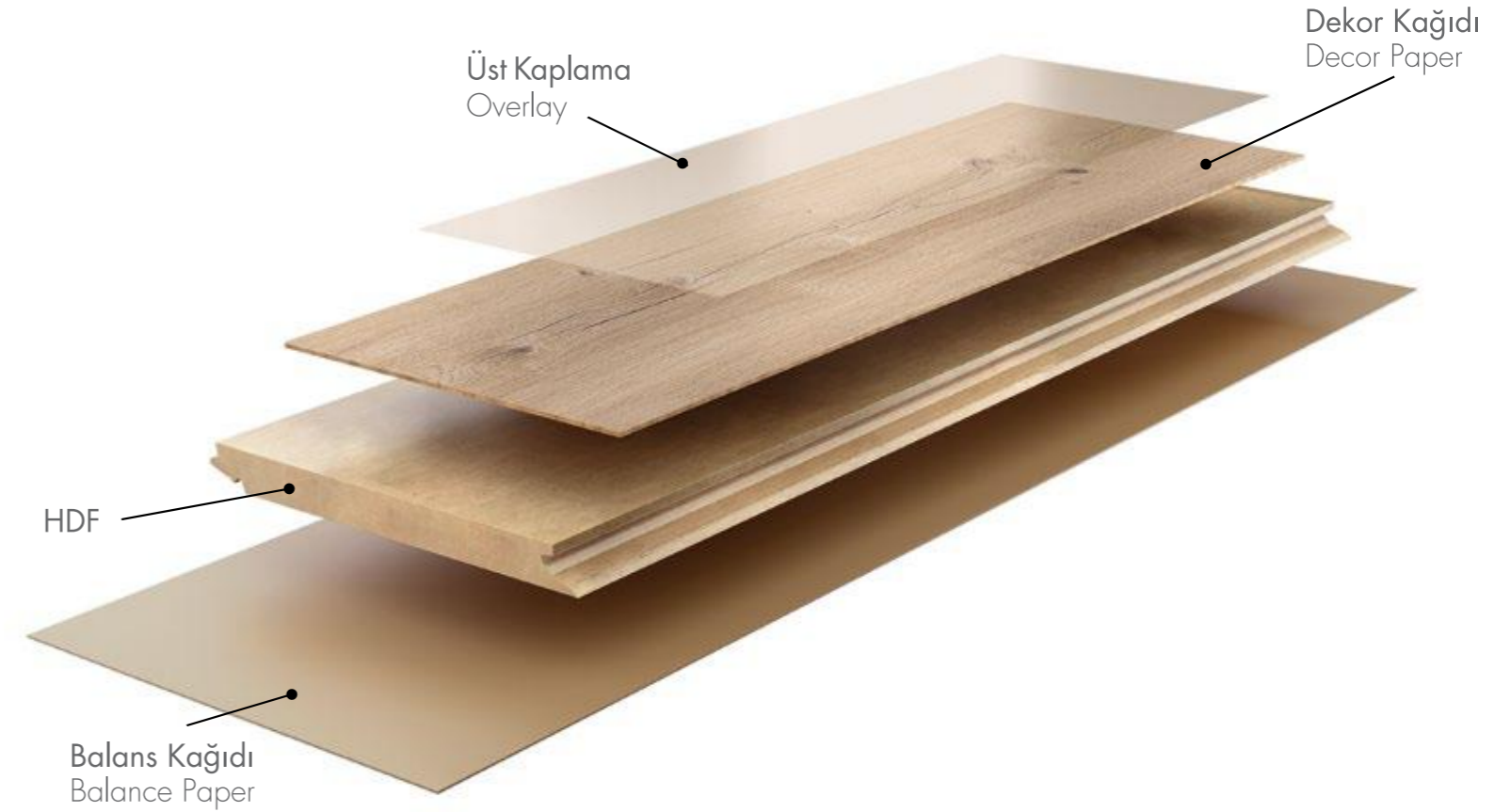

Üst Kaplama: Laminat parkeyi çizilmeden koruyan en üst katmandır.

Dekor Kağıdı: Laminat parkeye sonsuz renk ve desen özelliği verebilen dekoratif tabakadır.

HDF: Yüksek yoğunlukta lif levha tabakasıdır.

Balans Kağıdı: Stabilizasyonu sağlayan, nemden ve çarpılmadan koruyan tabakadır.

Overlay: Top layer protects laminate flooring from scratches.

Decor Paper: Decorative layer, which gives different alternative colours and designs to laminate flooring.

HDF: High density fiberboard.

Balance Paper: Bottom layer, which protects from humidity and distortion, provides stabilization.

Renkler basılı ve dijital kataloğlarda farklılık gösterebilir. Lütfen, satış noktalarımızda bulunan gerçek ürünler ile karşılaştırınız.

Colors may vary in digital and printed catalogs. Please compare with the actual products in the sales points.

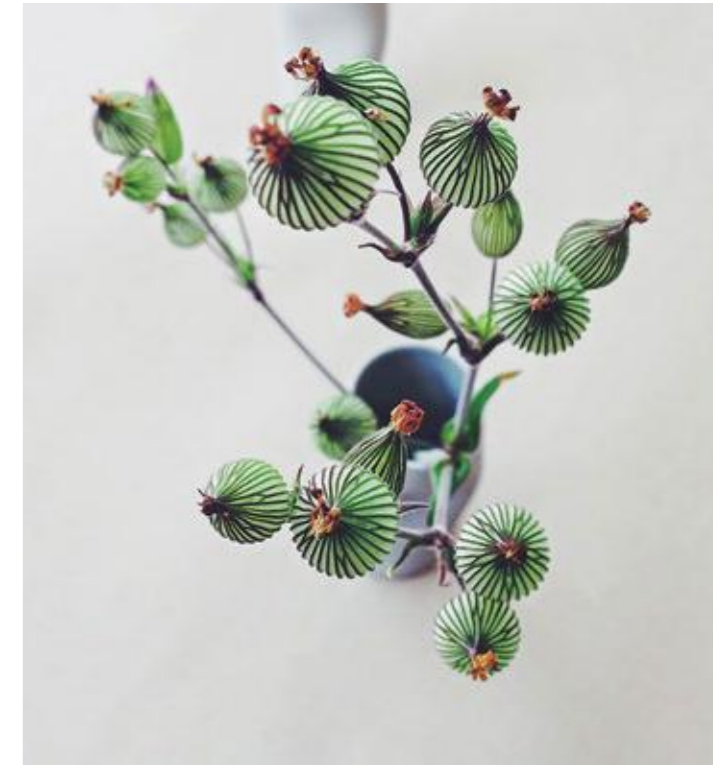

**Yenilik isteyene:
AGT Parke ve Süpürgelik.**

For innovation chasers...
AGT Flooring and Skirting.

**AGT Süpürgelikler, AGT Parkeler ile uyum sağlar.
Geniş renk ve model seçenekleriyle istediğiniz
görünümü elde ederek, evinize yenilik katabilirsiniz.**

AGT Skirting matches perfectly with AGT floorings. You
can get desired look, and bring innovation to your home,
thanks to its large color and model options.

Süpürgelik Profilleri / Skirting Profiles

Süpürgelik Modelleri İle Uyumlu Karkaslar/ Carcasses Compatible With Skirting Profiles

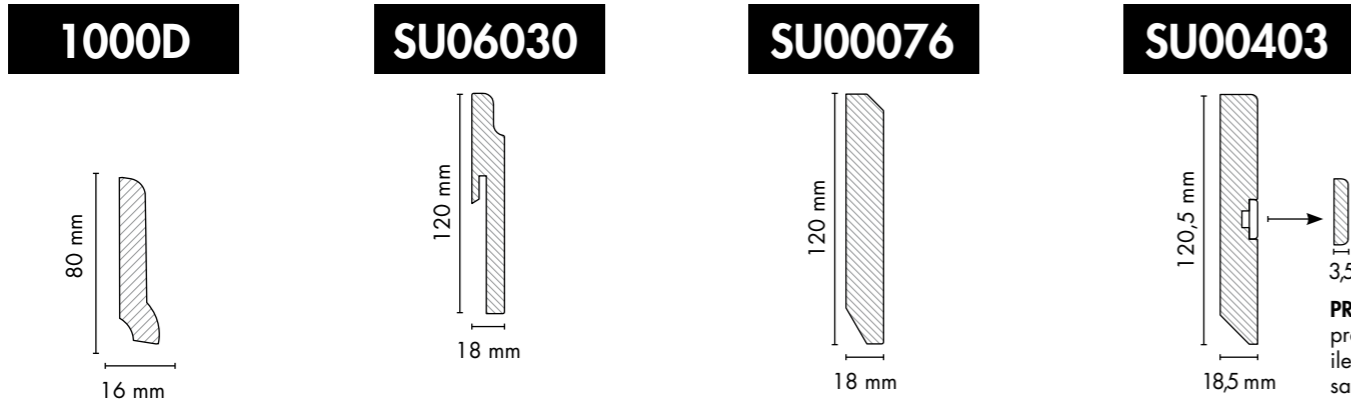
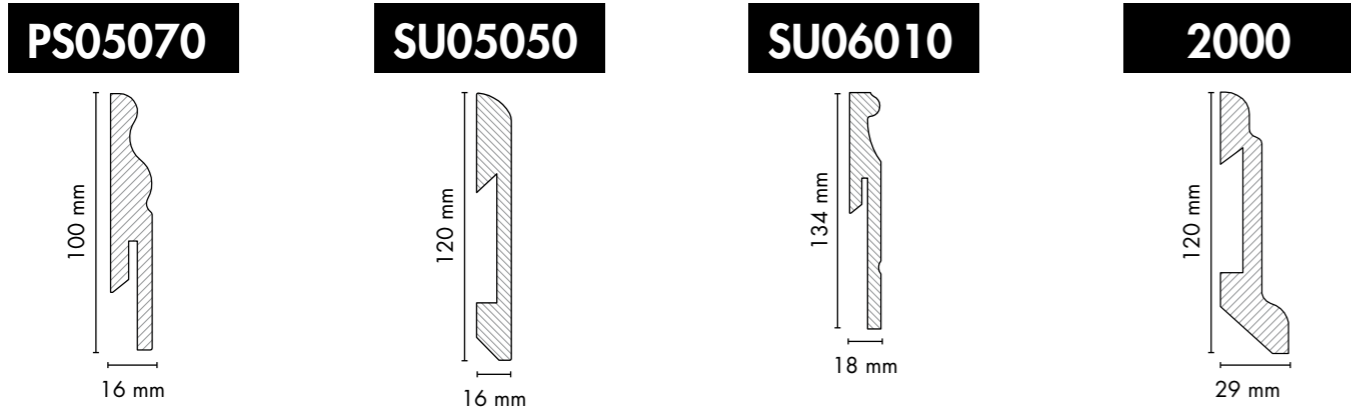
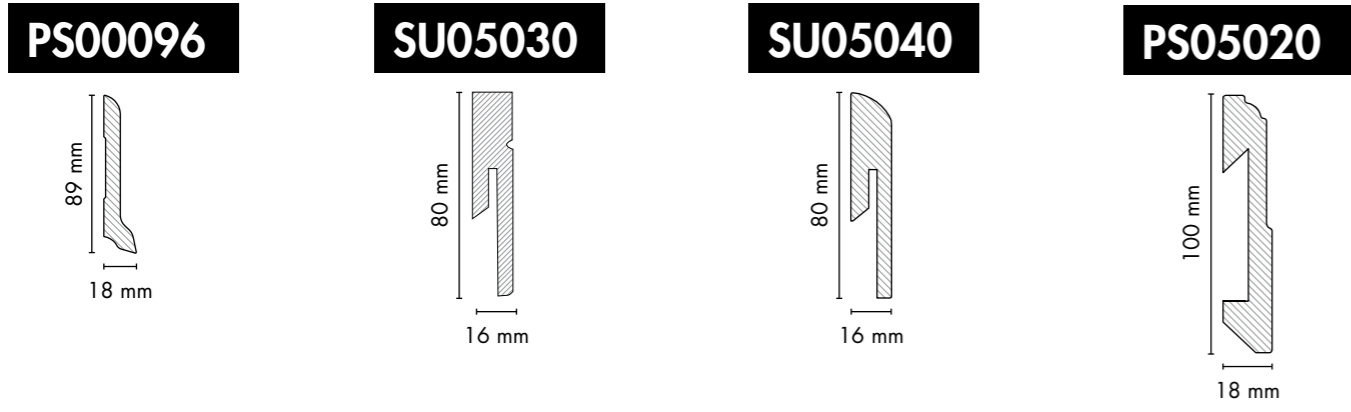
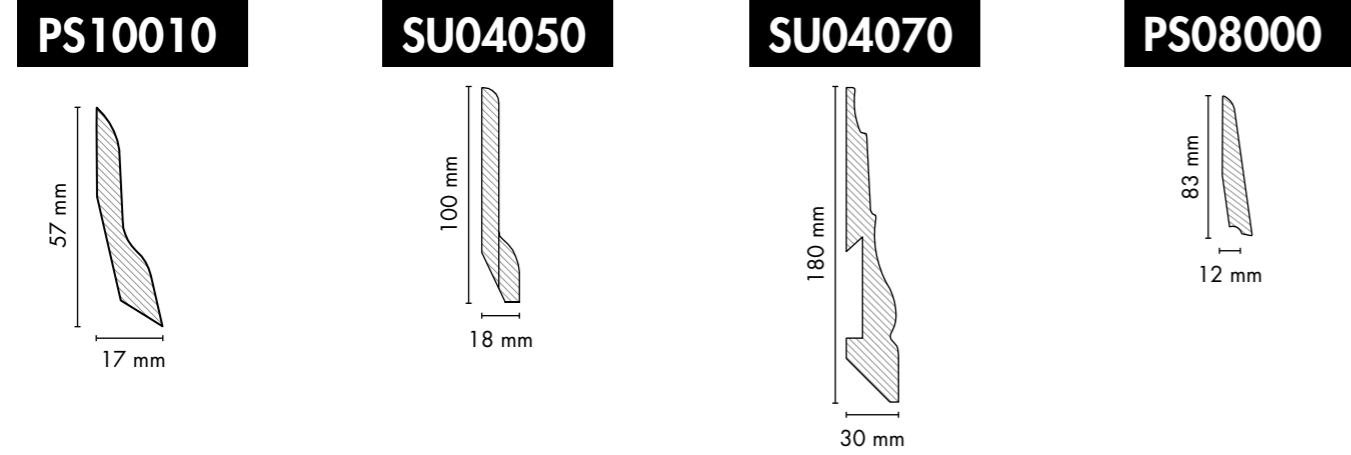

**Yeni
New**

PRO4233
profil çitası
ile birlikte
satılmaktadır.

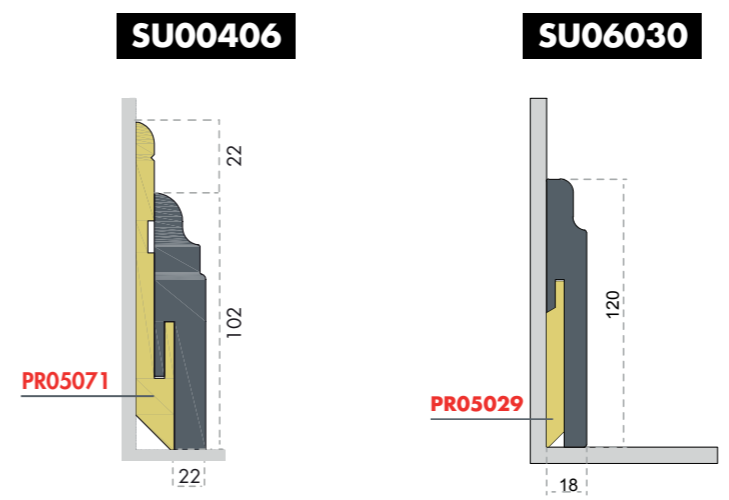
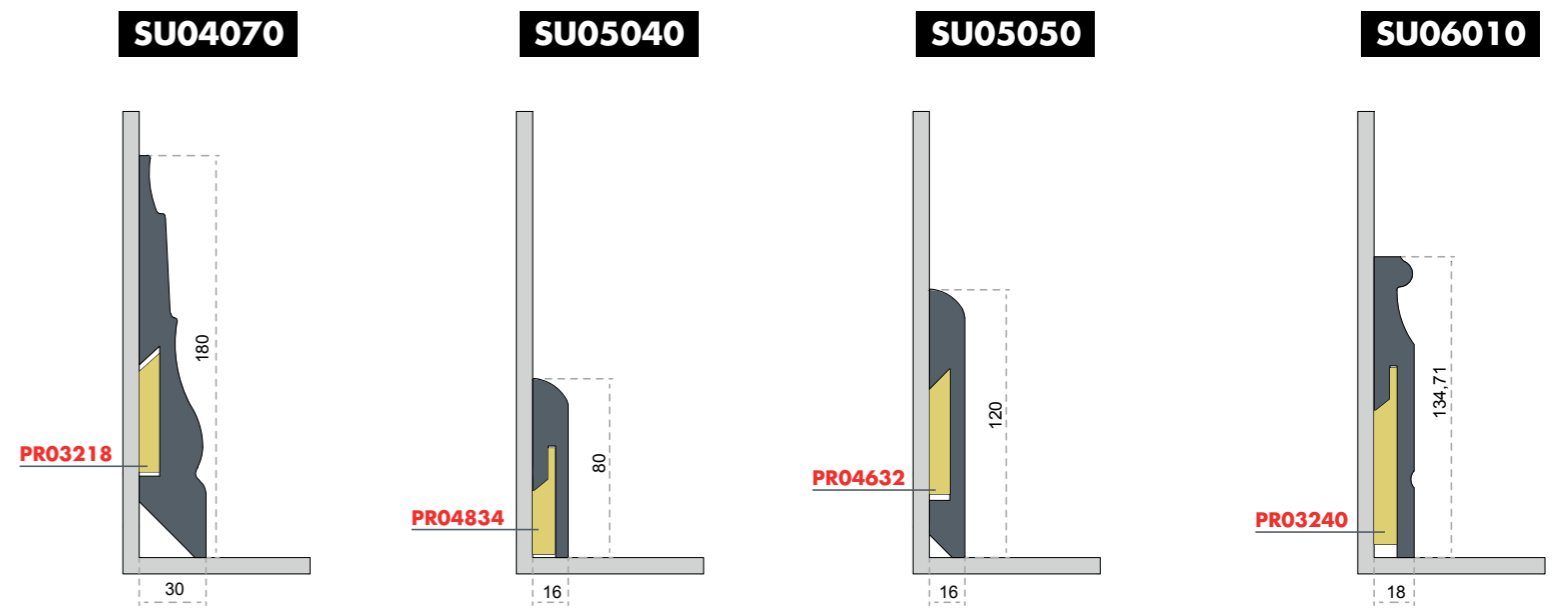
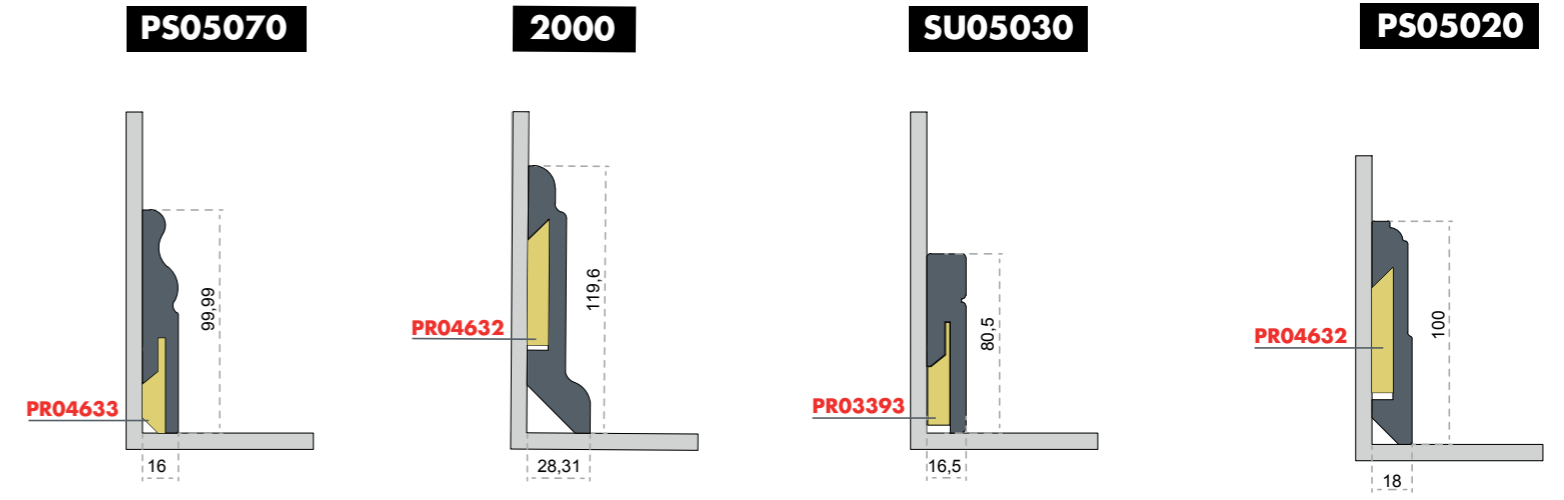

Effect Dekorlar
Effect Decors

Effect için önerilen
süpürgelik renkleri
Skirting color
suggestions for Effect

	alp		alp	
	pamir		pamir	
	ural		ural	
	fuji		fuji	
	tibet		tibet	
	altay		altay	
	everest		everest	
	toros		toros	



**HIZLI VE KOLAY
MONTAJ /
FAST AND EASY
ASSEMBLY**



**UV IŞINLARINA
DAYANIKLI /
RESISTANT TO UV
RAYS**



**ÇEVRE
DOSTU /
ENVIRONMENTALLY
FRIENDLY**



**MOBİLYA AYAKLARI
AŞINDIRMAZ /
RESISTANT TO FURNITURE
WHEEL ABRASION**



**TAŞIYICI LEVHA,
YÜKSEK YOĞUNLUKLU
LİF LEVHA /
BASE PANEL, HIGH
DENSITY FIBERBOARD**



**KOLAY TEMİZLENİR,
HİJYENİKTİR /
EASILY CLEANED
MAINTAINED AND HYGENIC**



**NOKTASAL DARBELERE
DAYANIKLI /
RESISTANT TO POINT
STRIKES**



**LEKELERDEN
ETKİLENMEZ /
NOT AFFECTED
BY STAINS**



**ÇİZİLMEME
DAYANIKLI /
RESISTANT TO
SCRATCH**

AGT'den bir yenilik daha. Mobil uygulamamız yayında! One More Innovation from AGT. Our Mobile App is Online!

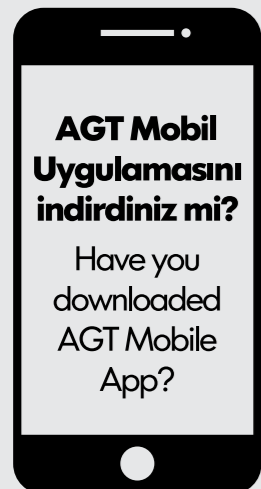
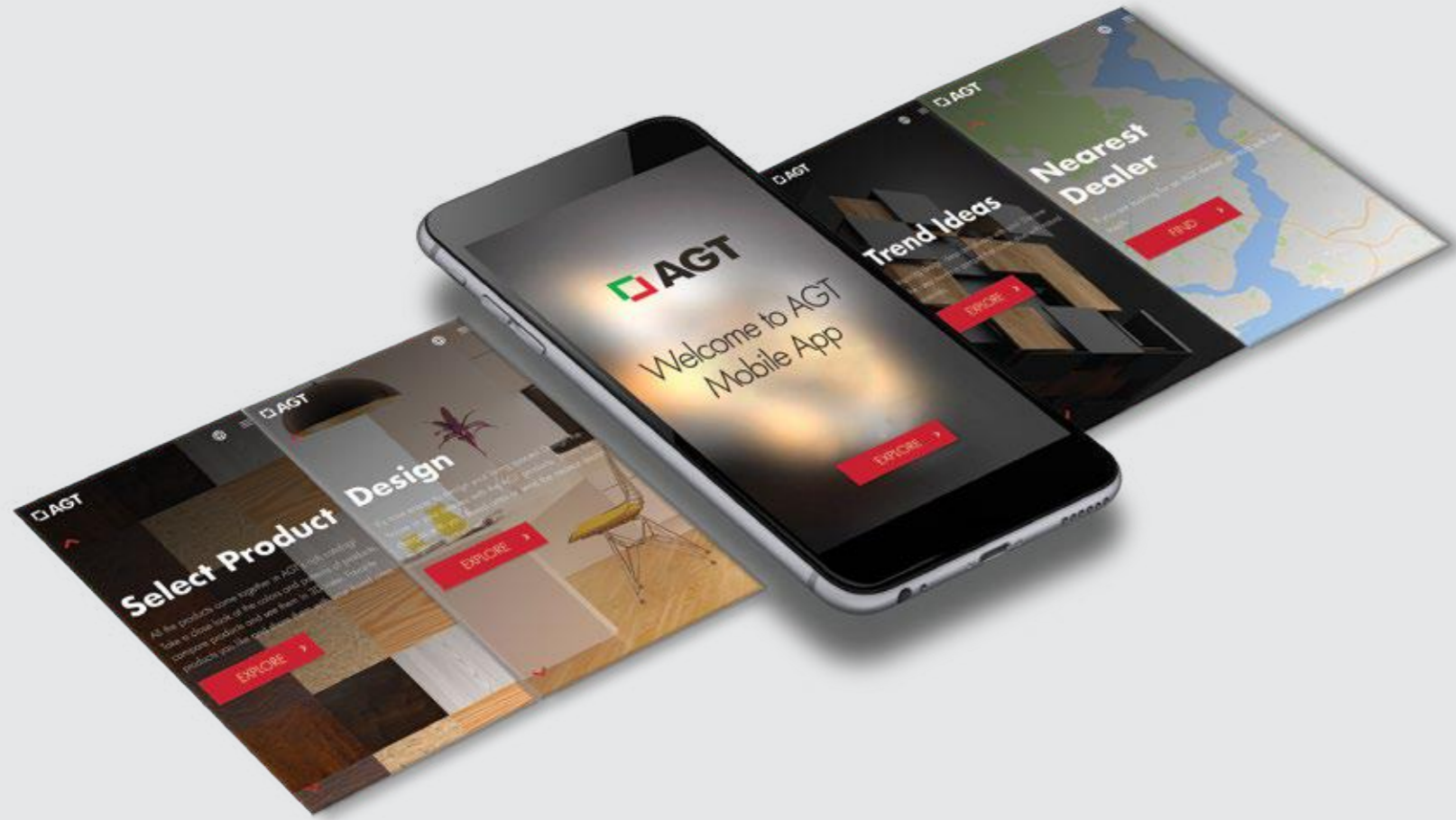

NOTLAR NOTES



agt.com.tr

[f](#) [t](#) [p](#) [i](#) [y](#) /agtthinkwithus

Merkez | Head Office

Organize Sanayi Bölgesi
3. Kısım, 35. Cadde, 07190
Döşemealtı, Antalya, Türkiye
Tel: +90 242 249 17 17
Fax: +90 242 249 17 27
agt@agt.com.tr

İstanbul Ofis | Istanbul Office

Kısıklı Mh. Alemdağ Cad. No: 36
34693 Çamlıca, İstanbul, Türkiye
Tel : +90 216 344 82 48
Fax : +90 216 316 82 48
istanbul@agt.com.tr